

PD7130  
PD7150  
DLP<sup>®</sup> Projector

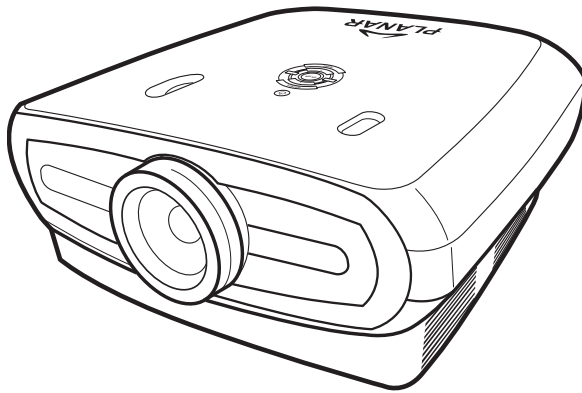

## User's Manual

[www.PlanarHomeTheater.com](http://www.PlanarHomeTheater.com)

## **Planar Systems, Inc.**

Corporate Headquarters  
1195 NW Compton Drive  
Beaverton, OR 97006-1992

### **Planar Customer Support**

Telephone:

US: 1-866-PLANAR1 (866) 752-6271

Outside US: (503) 748-5799

E-mail: [PlanarSupport@planar.com](mailto:PlanarSupport@planar.com)

Online Technical Library: <http://www.planar.com/support>

Hours: M-F, 8am-8pm ET, 12pm-12am GMT

## ABOUT THIS MANUAL

This manual is designed for use with the PD7130/PD7150 DLP Front Projector. Information in this document has been carefully checked for accuracy; however, no guarantee is given to the correctness of the contents. The information in this document is subject to change without notice.

## COPYRIGHT

© Copyright 2006

This document contains proprietary information protected by copyright. All rights are reserved. No part of this manual may be reproduced by any mechanical, electronic or other means, in any form, without prior written permission of the manufacturer

## TRADEMARKS

All trademarks and registered trademarks are the property of their respective owners.

## FCC COMPLIANCE

This device complies with Part 15 of the FCC Rules. Operation is subject to the following two conditions:

- (1) This device may not cause harmful interference, and
- (2) This device must accept any interference received, including interference that may cause undesired operation.

## FEDERAL COMMUNICATIONS COMISSION (FCC) STATEMENT

This equipment has been tested and found to comply with the limits for a Class B digital device, pursuant to part 15 of the FCC Rules. These limits are designed to provide reasonable protection against harmful interference in a residential installation. This equipment generates, uses and can radiate radio frequency energy and, if not installed and used in accordance with the instructions, may cause harmful interference to radio communications. However, there is no guarantee that interference will not occur in a particular installation. If this equipment does cause harmful interference to radio or television reception, which can be determined by turning the equipment off and on, the user is encouraged to try to correct the interference by one or more of the following measures:

Reorient or relocate the receiving antenna.

Increase the separation between the equipment and the receiver.

Connect the equipment to an outlet on a circuit different from that to which the receiver is connected.

Consult the dealer or an experienced radio/TV technician for help.

# Notices



**WARNING!** To meet FCC requirements, a shielded power cord is required in order to prevent interference. It is essential that only the supplied power cord is to be used. Use only shielded cables to connect I/O devices to this equipment. You are cautioned that changes or modifications not approved by the party responsible for compliance could void your authority to operate the equipment.



**WARNING!** The projector cooling fan continues to run for approximately 90 seconds after the projector is turned off using the Power button on the control panel or remote control. Never unplug the power cable to power off the projector; damage to the lamp may result.



**WARNING!** High brightness light source. Do not stare into the beam of light, or view directly. Be especially careful and ensure that children do not stare directly into the beam of light.



**WARNING!** To reduce the risk of fire or electric shock, do not expose this product to rain or moisture.



**CAUTION!** For minimal servicing and to maintain high image quality, we recommend that you use the projector in an environment that is smoke and dust free. When used in areas where there is a lot of smoke or dust, the filter and lens should be cleaned often to lengthen the service life of the projector.



**WARNING!** Some IC chips in this product include confidential and/or trade secret property belonging to Texas Instruments. Therefore you may not copy, modify, adapt, translate, distribute, reverse engineer, reverse assemble or decompile the contents thereof.



**WARNING!** The ventilation slots, lamp, and objects next to them may get extremely hot during operation. Do not touch these areas until they have sufficiently cooled down.

## PRODUCT DISPOSAL

This projector utilizes a tin-lead solder, UHP Lamp containing a small amount of mercury. Disposal of these materials may be regulated due to environmental considerations.

## IMPORTANT RECYCLING INSTRUCTIONS

	<p>Lamp(s) inside this product contain mercury. This product may contain other electronic waste that can be hazardous if not disposed of properly. Recycle or dispose in accordance with local, state, or federal Laws. For more information, contact the Electronic Industries Alliance at <a href="http://WWW.EIAE.ORG">WWW.EIAE.ORG</a>. For lamp specific disposal information check <a href="http://WWW.LAMPRECYCLE.ORG">WWW.LAMPRECYCLE.ORG</a>.</p>
---	--

## SYMBOL EXPLANATIONS

	<p><b>DISPOSAL:</b> Do not use household or municipal waste collection services for disposal of electrical and electronic equipment. EU countries require the use of separate recycling collection services.</p>
---	--

## REGISTER YOUR PLANAR PRODUCT TODAY

Thank you for choosing Planar. To assure you receive all the benefits of your Planar product and services, register your Planar product today. Visit our website:

[http://www.planar.com/support/product\\_registration.html](http://www.planar.com/support/product_registration.html)

## CABLES, REPLACEMENT LAMPS AND ACCESSORIES

To find cables, replacement lamps and accessories for your Planar projector, LCD monitor, touchscreen, or other Planar products, visit our online store: [www.PlanarOnline.com](http://www.PlanarOnline.com) or find other stores that stock Planar products at <http://www.planar.com/howtobuy>.



# Contents

Preface .....	i
Notices .....	ii
<b>Introduction</b>	
Package Contents .....	2
Features .....	2
Components .....	3
Projector (Front and Top View).....	3
Projector (Rear View).....	4
Remote Control.....	5
Using the Remote Control .....	6
Inserting the Batteries .....	6
<b>Connections and Setup</b>	
Connecting the Projector to Other Devices .....	8
Before Setting Up.....	8
Connecting the Power Cord.....	8
Connecting to Video Equipment.....	9
Connecting to Component Video Equipment.....	10
Connecting Using the DVI Cable .....	10
Connecting Using a DVI-D to HDMI Cable .....	11
Connecting the Projector to a Computer .....	12
Connecting the Thumbscrew Cables .....	13
“Plug and Play” Function .....	13
Adjustable Leveling Foot .....	14
Adjusting the Lens .....	14
Setting up the Screen .....	15
Screen Size and Projection Distance.....	16
Projection Mode .....	17
<b>Basic Operation</b>	
Image Projection .....	20
Basic Procedure.....	20
Using the Menu Screen .....	22
Menu Selections (Adjustments) .....	22
On-Screen Display Menu Items .....	23
On-Screen Display Menus .....	24
Picture Menu .....	24
Layout Menu .....	25
Selecting the Picture Display Mode .....	27
Option Menu .....	29
Input Source Menu.....	31
Language Menu .....	31

Factory Reset..... 31

**Appendix**

Maintenance..... 34

About the Lamp ..... 35

    Caution Concerning the Lamp ..... 35

    Replacing the Lamp ..... 35

    Temperature LED (Temperature Overheat Alarm) ..... 35

Removing and Replacing the Lamp ..... 36

Resetting the Lamp Timer ..... 37

Connecting Pin Assignments ..... 38

Computer Compatibility Chart ..... 39

Video Compatibility Chart..... 40

Troubleshooting..... 41

Product Specifications ..... 42







Dimensions..... 43



# Introduction

# Package Contents

Open the package and ensure that you have the following items:

		
Remote control	Two "AAA" size batteries	Power cord (By country)
		
User's Guide	CD (including this manual)	RGB Component Cable

## Features

- Newly developed LVDS (Low voltage differential signal) chip eliminates Color Breaking phenomena common with previous generation DLP™ projectors
- Use of high-output lamp realizes both high color purity and high brightness. Natural images made possible by high color reproducibility can be created with high-brightness, powerful expression capabilities
- Realizes vivid images using the latest image quality circuitry
- New I/P conversion algorithm enhances the performance of the motion detect I/P conversion
- Extensive improvements on the jagged edges or slanted lines in moving images
- New Edge Up-Scaling
- As a result of reducing jagged edges and flickering when up-scaling edges of slanted lines, even signals not reaching a panel resolution of 480i/p can be projected by converting them to 1280x720 resolution images
- New Film Mode Function
- 3:2 pull down enhancement for not only 480i and 576i signals, but HDTV 1080i signals as well
- White balance
- Use of a DVI-HDCP terminal enables all processes from input to signal processing and projection to be performed digitally, resulting in the realization of all-digital projection without any data loss due to analog conversion. This is also supports the building of home theaters using HTPC

# Components

## Projector (Front and Top View)

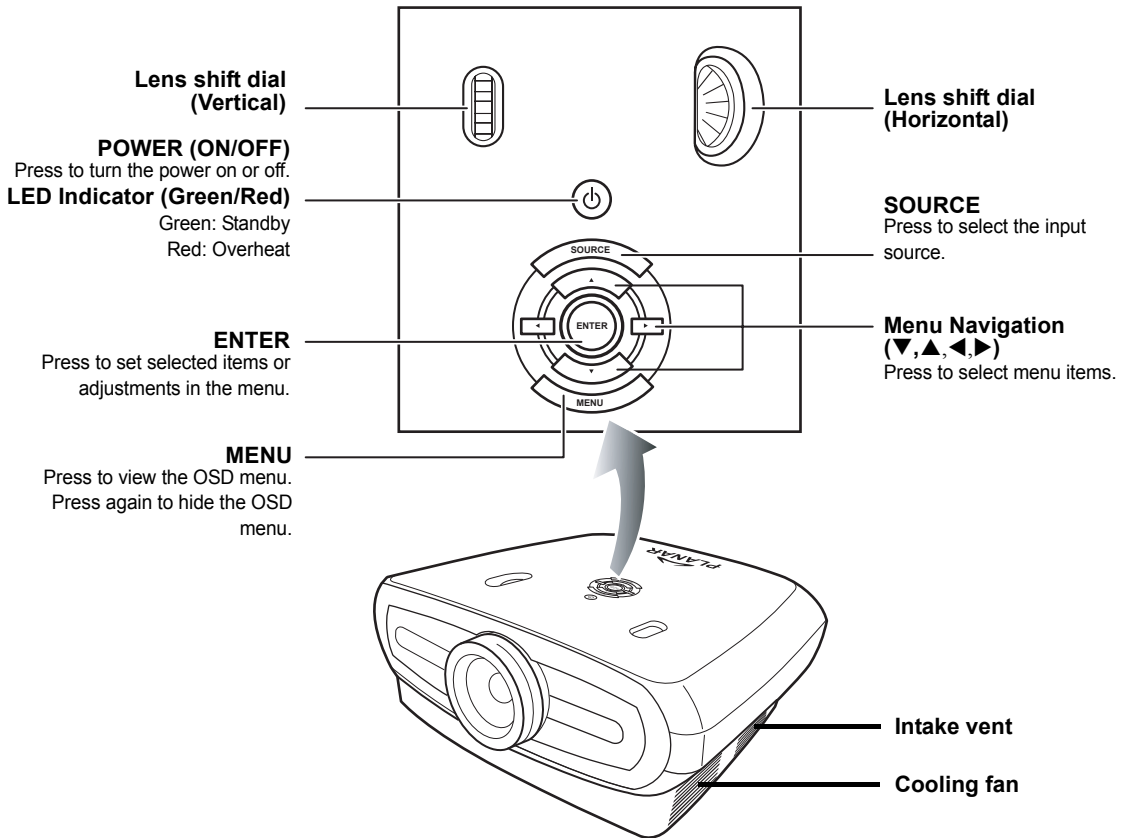

## Projector (Rear View)

### Source 5: Video/S-Video

Terminal for connecting video equipment with an S-video or Composite Video terminal.

### 12V Trigger

Terminal for screen controlling

### RS-232C terminal

Firmware upgrade/command control.

### Source 1: Component 1

Terminals for component YPbPr/YCbCr.

### Source 2: Component 2

Terminals for component and YPbPr/YCbCr.

### Source 3: DVI

Terminal for computer and RGB signals.

### Source 4: PC

Terminal for Digital Video Interface.

### AC socket

Input: 100~240VAC  
3.5A, 50/60Hz

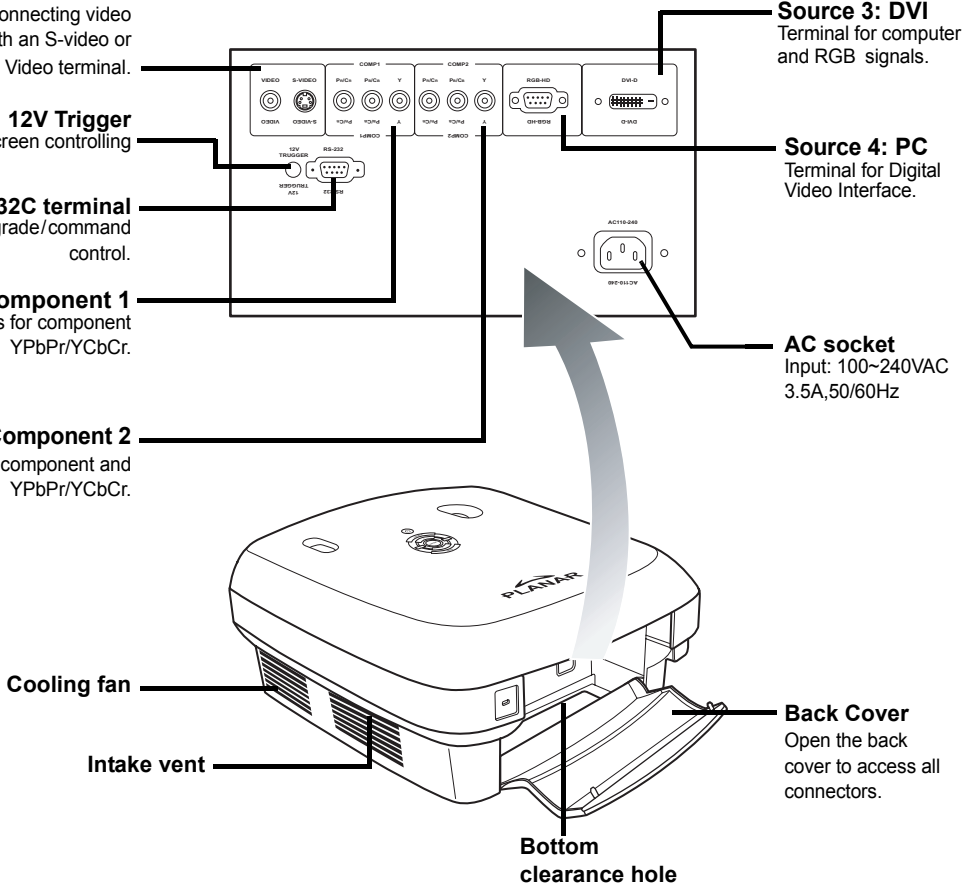

### Note

- Cables should run through the bottom clearance hole. The back cover allows for easy access to terminals and is intended to conceal the cables after installation.



**WARNING!** The projector lamp can reach high temperatures expelling uncomfortably hot air through the ventilation slots.

# Remote Control

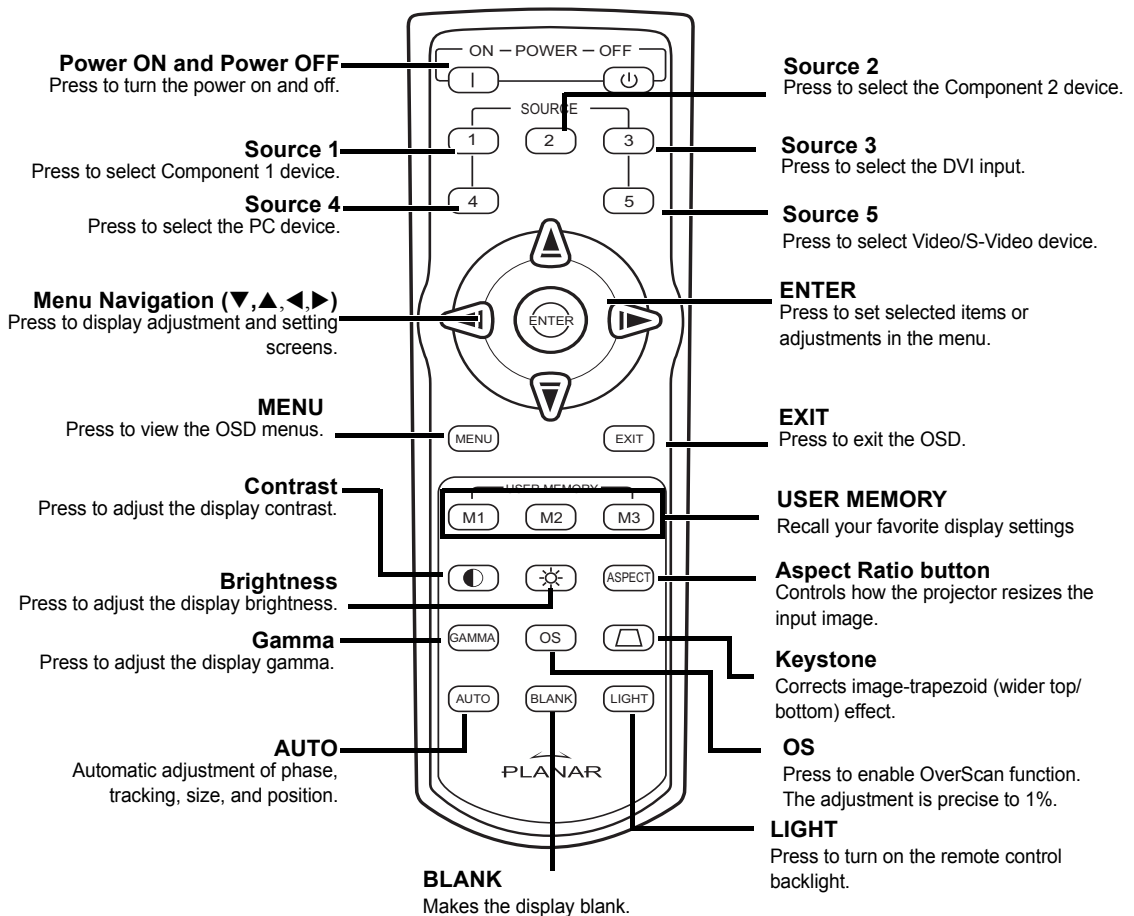

## Note

- See page 30 “Source Assign” on how to set your remote control buttons (Source 1/ Source 2/ Source 3/ Source 4/ Source 5) to a source.

# Using the Remote Control

## Note

- The signal from the remote control can be reflected by the screen.

### When using the remote control:

- Do not drop it, or expose it to moisture or high temperature.
- The remote control may not function correctly under fluorescent lamps. Operate the projector away from fluorescent lamps.

## Inserting the Batteries

The batteries (two “AAA”) are included in the package.

- 1 Press down the tab on the cover and slide the cover towards the direction of the arrow.**

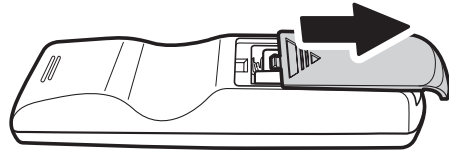

- 2 Insert the included batteries.**  
Make sure the polarities correctly match the  $\oplus$  and  $\ominus$  marks inside the battery compartment.

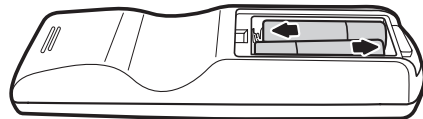

- 3 Insert the lower tab of the cover into the opening, and press down the cover until it clicks in place.**

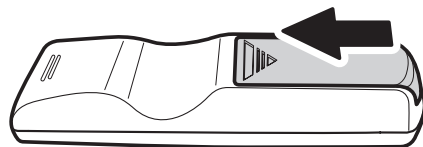

# Connections and Setup

# Connecting the Projector to Other Devices

## Before Setting Up

### Notes

- Before connecting, turn off both the projector and the devices to be connected. After making all connections, turn on the projector first and then the other devices.  
When connecting a computer, be sure that the computer is the last device turned on, after all connections are made.
- Read the operation manuals of the devices to be connected before making connections.

## This projector can be connected to

### Video equipment:

- A VCR, Laser disc player or other video equipment.
- A DVD player or DTV\* decoder.
- High Definition sources

\*DTV is the umbrella term used to describe the new digital television system.

### A computer, using:

- A HD 15-pin VGA to HD 15-pin VGA cable (sold separately), or
- A DVI-D to DVI-D cable (sold separately), or
- An RS-232C cable (sold separately).

## Connecting the Power Cord

Plug the supplied power cord into the AC socket on the rear of the projector.

Supplied  
accessory



Power cord

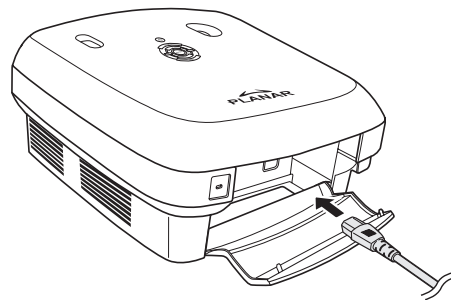





## Connecting to Component Video Equipment

### Using a Component Cable (Component 1 or 2)

Use a component cable when connecting component video equipment such as DVD players and DTV\* decoders to the Component 1 or 2 terminals.

\*DTV is an umbrella term used to describe the new digital television system.

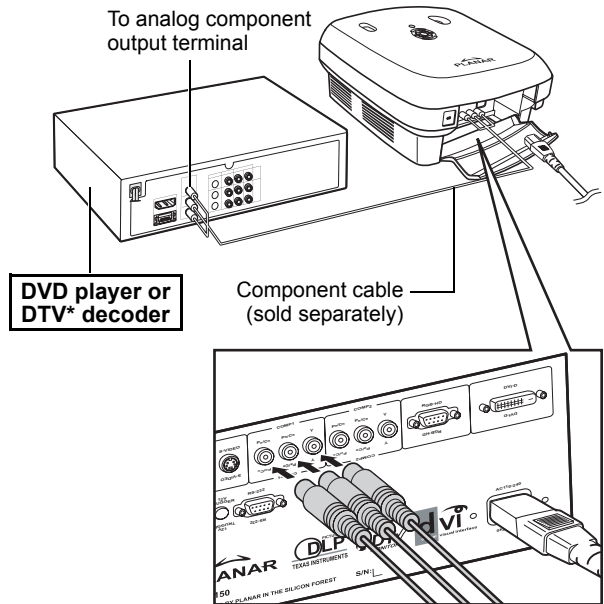

#### Note

- When connecting the projector to video equipment in this way, set "Input Source" to "Component 1 or 2" in the "Main" menu.

The device's component jacks may be labeled Y, CB and CR. Connect each jack as shown below.

Projector	Y	PB	PR
	↓	↑	↑
DVD player or DTV decoder	Y	CB	CR

## Connecting Using the DVI Cable

Use the DVI cable when connecting video equipment with DVI output such as DVD players and DTV\* decoders to the DVI terminal.

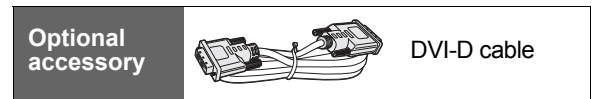

#### Note

- Select the input signal type of the video equipment.

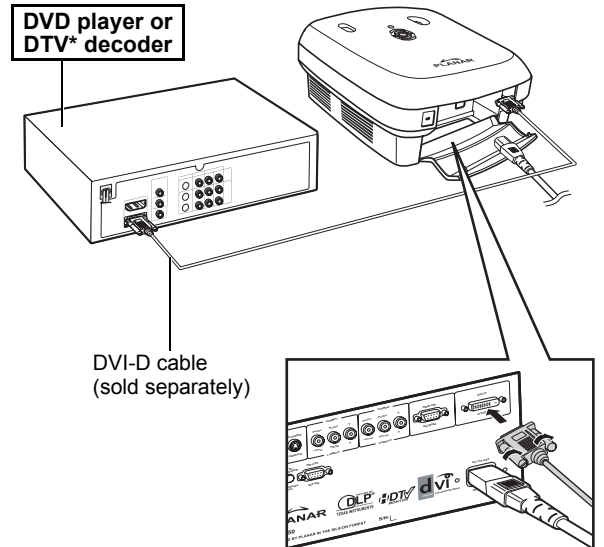

## Connecting Using a DVI-D to HDMI Cable

Use a DVI to HDMI cable when connecting HDMI video equipment such as DVD players to the DVI terminal.

- 1 Connect a DVI-D to HDMI cable to the projector.**
  - Secure the connectors by tightening the thumbscrews.
- 2 Connect the above cable to the video equipment.**



### Note

- Select the input signal type of the video equipment.

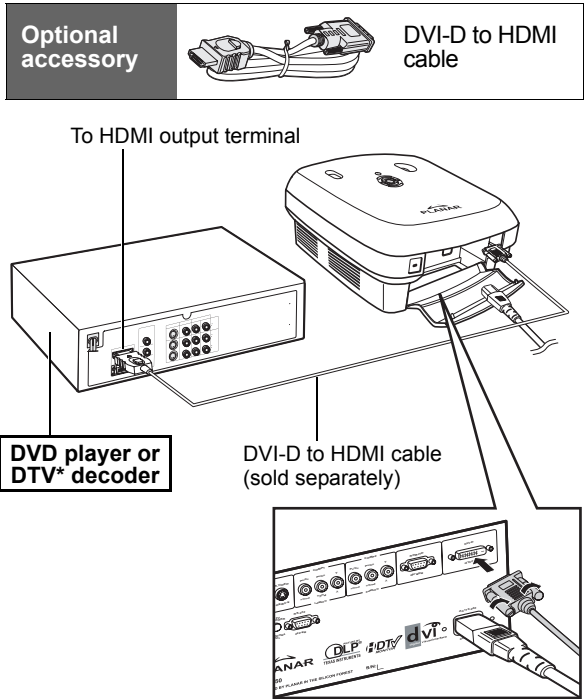

# Connecting the Projector to a Computer

Connect the projector to the computer using an HD 15-pin VGA cable.

- Secure the cable connectors by tightening the screws on both sides of the plug.

Optional  
accessory



HD 15-pin  
VGA cable

## Notes

- See page 39 “Computer Compatibility Chart” for a list of computer signals compatible with the projector. Using computer signals other than those listed may cause some of the functions not to work.
- When connecting the projector to a computer using an HD 15-pin VGA cable, set the “Input Source” to “PC” in the “Main” menu, or select RGB mode by pressing the Source 3 or 4 button on the remote control.
- A Macintosh adaptor may be required for use with some Macintosh computers. Contact your nearest authorized service center or dealer.
- Depending on the computer you are using, an image may not be projected unless the signal output setting of the computer is switched to the external output. Refer to the computer operation manual for switching the computer signal output settings.

Notebook Computer

HD 15-pin VGA cable  
(sold separately)

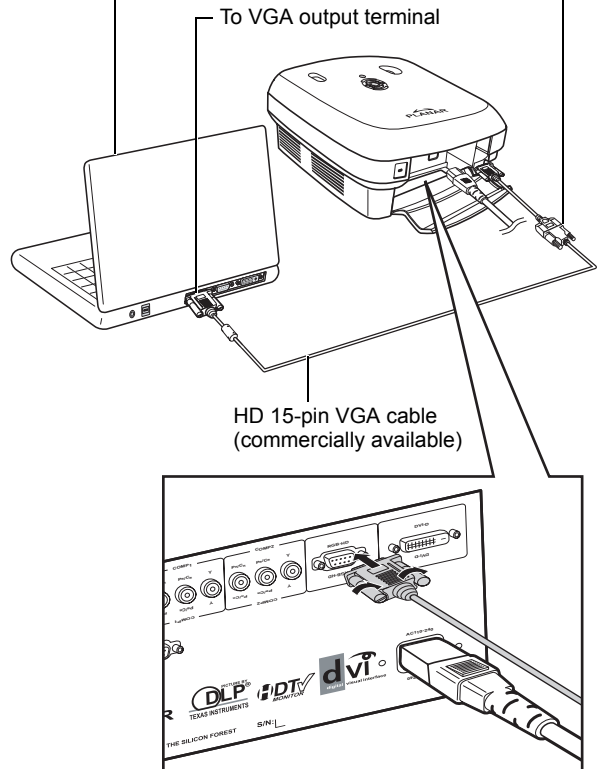

Connect the projector to the computer using a DVI-D cable (sold separately).

Optional  
accessory



DVI-D cable

 **Note**

- Select the input signal type of the video equipment.

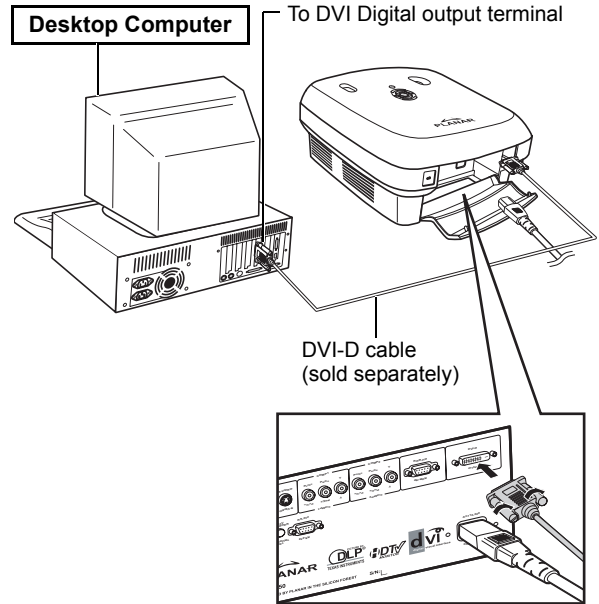

## Connecting the Thumbscrew Cables

- Connect the cable making sure that it fits correctly into the terminal. Secure the connectors by tightening the screws on both sides of the plug.
- Do not remove the ferrite cores attached to the cable.

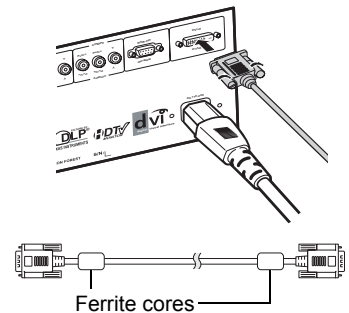

## “Plug and Play” Function

- This projector is compatible with VESA-standard DDC 1/DDC 2B. The projector and a VESA DDC compatible computer automatically send settings, allowing for quick and easy setup.
- Before using the “Plug and Play” function, be sure to turn on the projector first and the computer last.

 **Note**

- The DDC “Plug and Play” function of this projector operates only when used in conjunction with a VESA DDC compatible computer.

# Adjustable Leveling Foot

Use the adjustable foot to level the projector when it is placed on an uneven surface or when the screen is slanted.

The projected image can be made higher by adjusting the projector when it is lower than the screen.

- 1 Hold the projector firmly and screw the adjustable foot to adjust the projector to the desired angle.
  - 2 Lift the projector to the desired angle and screw the adjustable foot to fix the level.
- If the screen is at an angle, the adjustable feet can be used to alter the angle of the image.

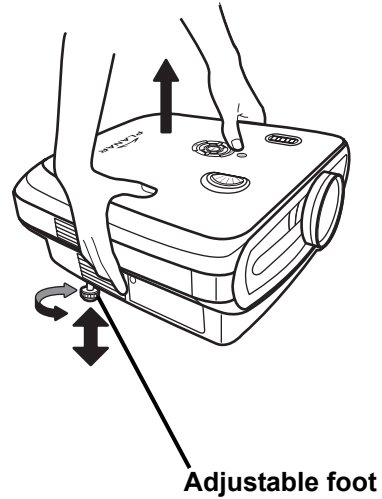

## Notes

- The projector is adjustable up to approximately 5-degrees from the standard position.
- When the height of the projector is adjusted, the image may become distorted (keystoned), depending on the relative positions of the projector and the screen. See "Layout Menu" on page 25 for details on keystone correction.

## Info

- When lowering the projector, be careful not to catch your fingers between the adjustment foot and the projector.

# Adjusting the Lens

Adjust the lens using the focus and zoom rings to correct the image.

- 1 Adjust zoom by rotating the zoom ring.
- 2 Adjust focus by moving the focus ring.

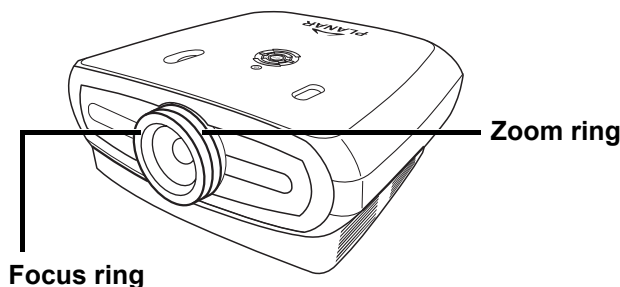

# Setting up the Screen

Position the projector perpendicular to the screen with all feet flat and level to achieve an optimal image.

## Notes

- The projector lens should be perpendicular (square-on) to the screen. If the horizontal line passing through the lens center is not perpendicular to the screen, the image will be distorted, making viewing difficult.
- For an optimal image, position the screen so that it is not in direct sunlight or room light. Light falling directly on the screen washes out the colors, making viewing difficult. Close curtains and dim the lights when setting up the screen in a sunny or bright room.
- A polarizing screen cannot be used with this projector.

## Standard Setup (Front Projection)

- Place the projector at the required distance from the screen according to the desired picture size. (See page 16)

## An Example of Standard Setup

### Side View

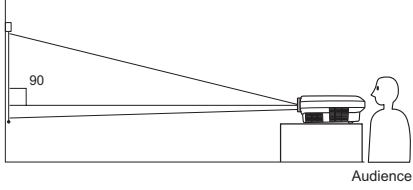

- The distance from the screen to the projector depends on the size of the screen.
- The default setting can be used, when placing the projector in front of the screen. If the projected image is reversed or inverted, readjust the setting to “Front” for “PRJ Mode” in the “Options” menu.

### Top View

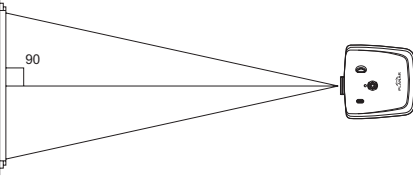

- Place the projector so that an imaginary horizontal line that passes through the center of the lens is perpendicular to the screen.

## Screen Size and Projection Distance

When using a wide screen (16:9) project the image on the whole area of the 16:9 screen.

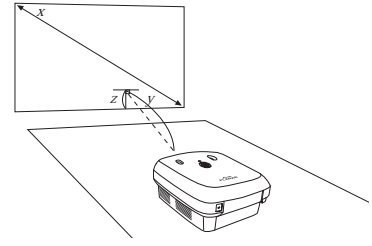
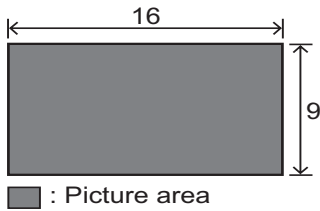

x: Screen size (diag.)  
y: Projection distance  
z: Distance from the lens center to the lower edge of the image

### PD7130

Screen Size (16:9)			Projection Distance		Distance from lens center to the lower edge of the image	
Diagonal	Width	Height	Max	Min	upper	lower
60" (152 cm)	52" (132 cm)	29" (75 cm)	7'7" (2.3 m)	6'1" (1.8 m)	0" (0 cm)	-2'5" (-75 cm)
70" (178 cm)	61" (155 cm)	34" (87 cm)	8'10" (2.7 m)	7'1" (2.1 m)	0" (0 cm)	-2'10" (-87 cm)
80" (203 cm)	70" (177 cm)	39" (100 cm)	10'1" (3.1 m)	8'1" (2.5 m)	0" (0 cm)	-3'3" (-100 cm)
90" (229 cm)	78" (199 cm)	44" (112 cm)	11'4" (3.5 m)	9'1" (2.8 m)	0" (0 cm)	-3'8" (-112 cm)
100" (254 cm)	87" (221 cm)	49" (125 cm)	12'7" (3.8 m)	10'1" (3.1 m)	0" (0 cm)	-4'1" (-125 cm)
110" (279 cm)	96" (244 cm)	54" (137 cm)	13'10" (4.2 m)	11'1" (3.4 m)	0" (0 cm)	-4'6" (-137 cm)
120" (305 cm)	105" (266 cm)	59" (149 cm)	15'1" (4.6 m)	12'1" (3.7 m)	0" (0 cm)	-4'11" (-149 cm)

### PD7150

Screen Size (16:9)			Projection Distance		Distance from lens center to the lower edge of the image	
Diagonal	Width	Height	Max	Min	upper	lower
60" (152 cm)	52" (132 cm)	29" (75 cm)	7'6" (2.3 m)	6'00" (1.8 m)	0" (0 cm)	-2'5" (-75 cm)
70" (178 cm)	61" (155 cm)	34" (87 cm)	8'9" (2.7 m)	7'00" (2.1 m)	0" (0 cm)	-2'10" (-87 cm)
80" (203 cm)	70" (177 cm)	39" (100 cm)	10'00" (3.0 m)	8'00" (2.4 m)	0" (0 cm)	-3'3" (-100 cm)
90" (229 cm)	78" (199 cm)	44" (112 cm)	11'3" (3.4 m)	9'00" (2.7 m)	0" (0 cm)	-3'8" (-112 cm)
100" (254 cm)	87" (221 cm)	49" (125 cm)	12'6" (3.8 m)	9'11" (3.0 m)	0" (0 cm)	-4'1" (-125 cm)
110" (279 cm)	96" (244 cm)	54" (137 cm)	13'9" (4.2 m)	10'11" (3.3 m)	0" (0 cm)	-4'6" (-137 cm)
120" (305 cm)	105" (266 cm)	59" (149 cm)	15'00" (4.6 m)	11'11" (3.6 m)	0" (0 cm)	-4'11" (-149 cm)



## Projection Mode

### Rear mode:

- Place a translucent screen between the projector and the audience. Use the adjustable foot to level the screen angle.

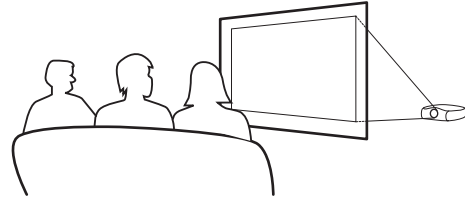

### Front mode:

- Place the projector on a flat and stable object and adjust the projecting distance. Use the adjustable foot to level the screen angle.

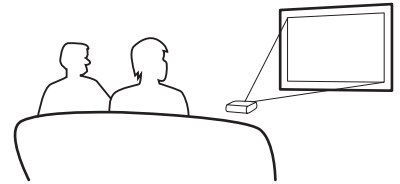

### Ceiling-mount setup

- The optional ceiling-mount bracket is recommended for this installation.
- Before mounting the projector, contact your nearest Authorized Service Center or Dealer to obtain the recommended ceiling-mount bracket (sold separately).
- Adjust the position of the projector to match the distance from the lens center position to the lower edge of the image, when mounting the projector on the ceiling.

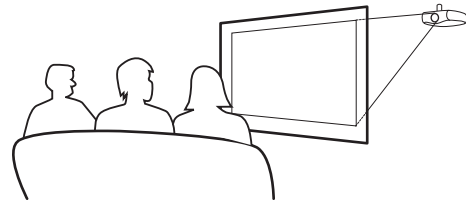
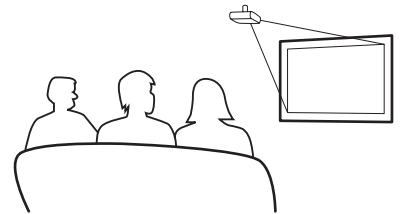



# Basic Operation



# Image Projection

## Basic Procedure

Connect the required external equipment to the projector before following these procedures.

### Info

The preset language is English. To change the on-screen display to another language, reset the language according to the procedure on page 31.

- 1 Plug the power cord into the wall outlet.**
  - The power indicator turns green, and the projector enters standby mode.
- 2 Press  on the remote control or  on the projector.**
  - The power indicator turns off, and the projector is turned on.

### Notes

- The power indicator illuminates, indicating the status of the lamp.  
**Green:** The power is ready.  
**Green blinking:** The fan is cooling.
- Please refer to “Projector (Front and Top View)” on page 3 for button details.

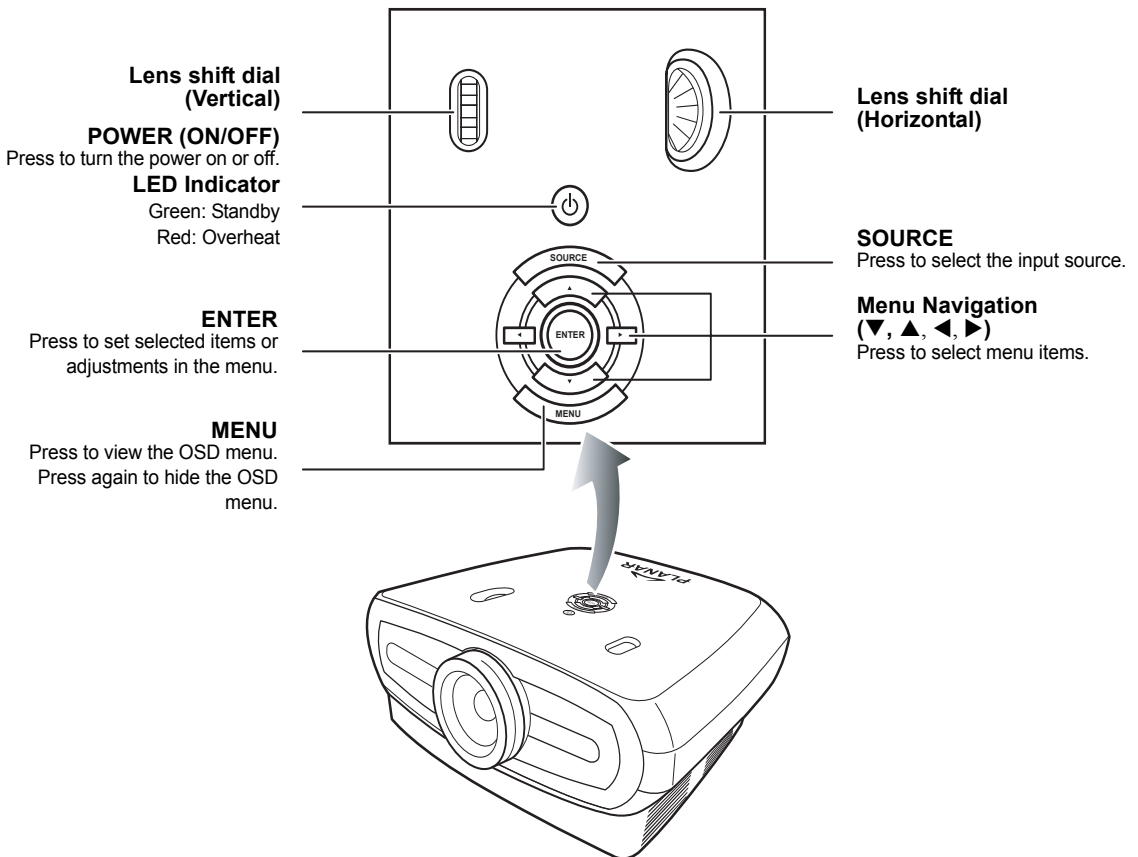

**3** Press  on the projector to select the source.

**About the sources**

S-Video	Use this option to select the S-Video input source.
Video	Use this option to select the composite video input source.
Component 1&2	Use this option to select a YPbPr, SDTV, or HDTV component input source.
DVI	Use this option to select the DVI input source.
PC	Use this option to select the computer as an input source.

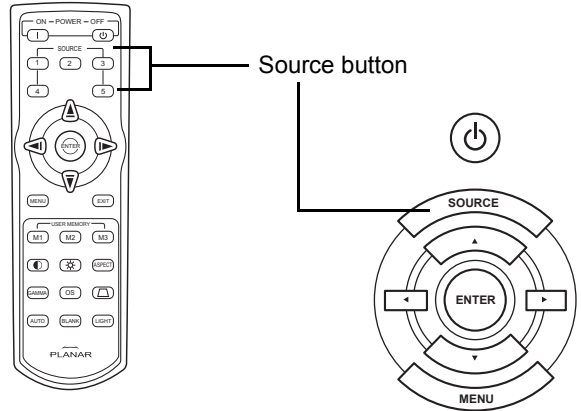

 **Notes**

- When a signal is not received, “Searching” is displayed.
- If you select “Auto” as the input source, then the correct input source is automatically selected.

**4** To turn off the projector, press the  on the remote controller. Or press  on the projector and then  when the confirmation message is displayed.

 **Notes**



- If you accidentally press power **OFF** and do not want to turn off the projector, press **Exit** or wait until the confirmation message closes.
- Do not unplug the power cord during projection or cooling fan operation. This can cause damage due to the rise in internal temperature, as the cooling fan also stops.

# Using the Menu Screen

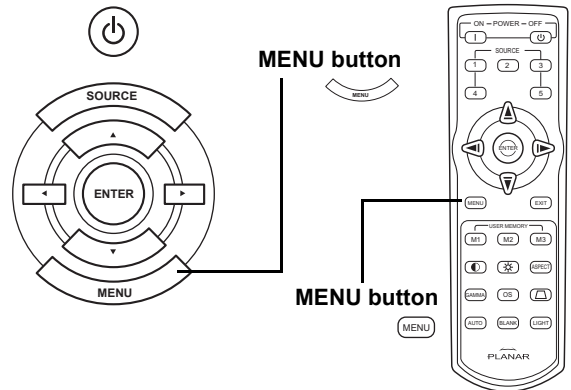
You can use the menu screens to adjust the image and projector settings. You can operate the menus from the projector or remote control using the following procedure.



## Menu Selections (Adjustments)





**1** Press  on remote or  on the keypad.

- The menu screen is displayed.

### Note

- The “Picture” menu screen for the selected input mode is displayed.

**2** Press  or  to select the menu you want to adjust.

**3** Press  or  to reach the Sub-menu and then press  or  to select the item you want to adjust.

### Note

- The selected item will be highlighted.

**4** Press  or  to adjust the selected item.

- The adjustment is stored.

**5** Press  on remote or  on the keypad to return to “Main MENU”.

**6** Press  on remote or  on the keypad to close the menu screen.

# On-Screen Display Menu Items

This list shows the items that can be set in the projector.

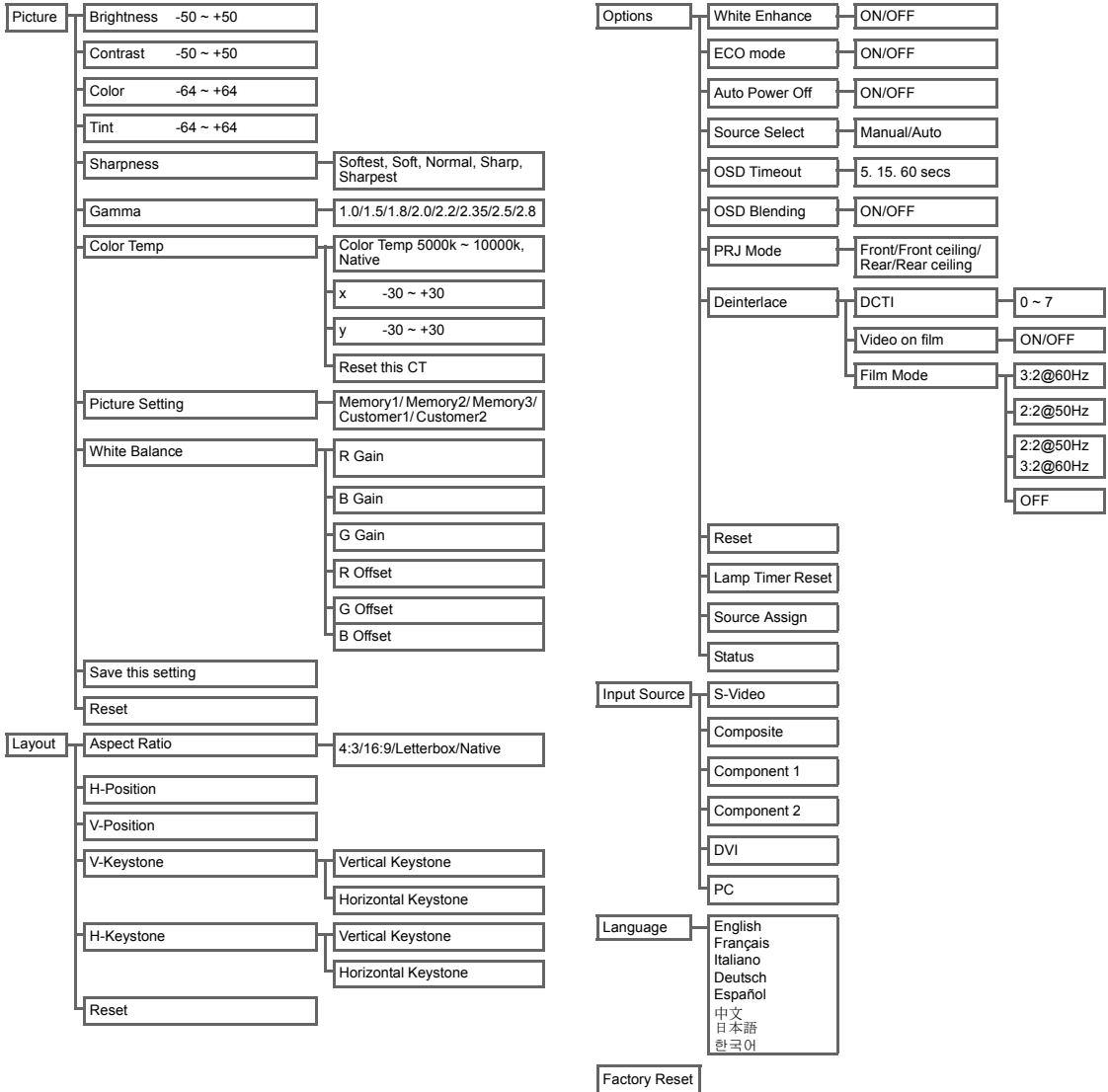

# On-Screen Display Menus

## Picture Menu

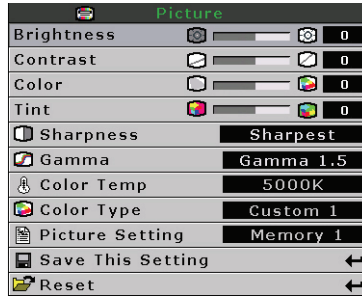

Item	Description	Default
Brightness	Press ◀ or ▶ button to adjust the brightness.	0
Contrast	Press ◀ or ▶ button to adjust the contrast.	0
Color	Press ◀ or ▶ button to adjust the screen color.	0
Tint	Press ◀ or ▶ button to adjust the video tint/hue. Press ▶ to make the image more green. Press ◀ to make the image ore purple.	0
Sharpness	Press ◀ or ▶ button to adjust the display sharpness. Select from Softest, Soft, Normal, Sharp, or Sharpest.	Normal
Gamma	Press ◀ or ▶ button to adjust the gamma correction of the display.	2.2
Color Temp	Press ◀ or ▶ button to adjust the color temperature. Select from Native, or use ◀ or ▶ button to adjust the X/Y value, or Reset the CT.	6500
Picture Setting	Press ◀ or ▶ button to adjust the picture display setting. Select from Memory1, Memory2, Memory3, Custom 1 or Custom 2.	Memory1
White Balance	The contrast and brightness for each color of the RGB Gain & Offset values in White Balance can be individually adjusted. Select "White Balance" from the picture menu on the menu screen, and then press Ⓜ. Press ◀ or ▶ button to adjust the individual value.	
Save This Setting	Press Ⓜ button to save the current setting.	N/A
Reset	Press Ⓜ button to return to the default setting.	N/A



# Layout Menu

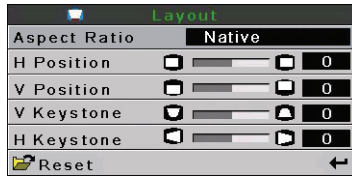

Item	Description
Aspect Ratio	<p>Press ◀ or ▶ button to toggle between the display formats. Select from 4:3, 16:9, LetterBox or Native.</p> <p><b>4:3</b></p> <ul style="list-style-type: none"> <li>Resolution depends on the input signal</li> <li>4:3 input scaled to fit display height</li> <li>Width scaled to maintain 4:3 aspect ratio</li> <li>Black bars on left and right (taking up 25% of the whole display)</li> </ul> <p><b>16:9</b></p> <ul style="list-style-type: none"> <li>Resolution: 16:9</li> <li>4:3 input is stretched to fit 16:9 display.</li> <li>Stretches entire image.</li> </ul> <p><b>LetterBox</b></p> <ul style="list-style-type: none"> <li>Resolution 1280 x 720</li> <li>4:3 input scaled to fit display width</li> <li>Height scaled to maintain 4:3 aspect ratio: 1280 x 960</li> <li>25% of the entire image on the top and bottom is cropped</li> </ul> <p><b>Native</b></p> <ul style="list-style-type: none"> <li>Maintains input signal resolution. May have black borders around image.</li> </ul> <p>For detailed information on Aspect Ratio, please see “Selecting the Picture Display Mode” on page 27.</p>
H Position	<p>Press ◀ or ▶ button to move the image left or right</p>
V Position	<p>Press ◀ or ▶ button to move the image up or down.</p>
V Keystone	<p>Press ◀ or ▶ button to correct distortion of the projected image.</p>

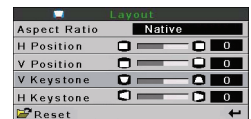
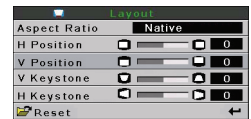
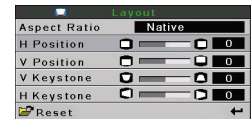
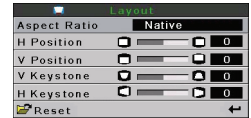

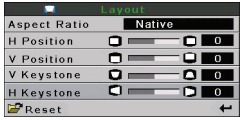

<p>H Keystone</p>	<p>Press ◀ or ▶ button to correct the distortion of the projected image</p> <p><b>Note:</b></p> <ul style="list-style-type: none"> <li>• When the image is projected at an angle, the image becomes distorted trapezoidal.</li> <li>• The function for correcting trapezoidal distortion is called Keystone Correction.</li> <li>• Keystone Correction can be corrected by adjusting the angle of projection.</li> <li>• The trapezoidal distortion of the image can be corrected by adjusting the angle of projection. The actual screen can also be set at an angle.</li> <li>• Straight lines or the edges of images may appear jagged while adjusting the image.</li> </ul>	
<p>Reset</p>	<p>Press ⏪ button to return to the default setting.</p>	

# Selecting the Picture Display Mode

## VIDEO

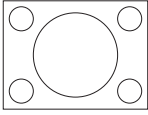
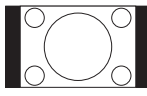
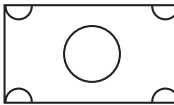
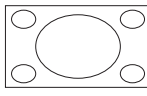
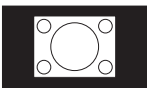
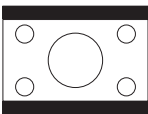
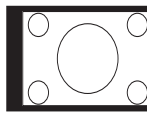
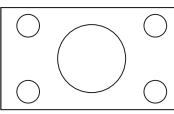
		4:3	Letterbox	16:9	Native
For 4:3 aspect ratio	480i 480p 576i 576p NTSC PAL SECAM	768X576	1280X720	1280X720	640X480i 640X480p 768X576i 768X576p 640X480 768X576 768X576
For 16:9 aspect ratio	480p 576p	768X576 768X576	1280X720 1280X720	1280X720	720X480 720X576
	720p	-	-	1280x720	-
	1080i	-	-	1280x720	-

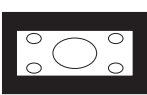
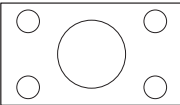
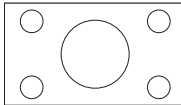
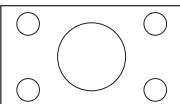
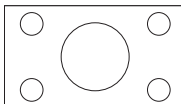
	Input Signal	Output screen image			
		4:3	Letterbox	16:9	Native
480i 480p 576i 576p NTSC PAL SECAM	 For 4:3 aspect ratio				
	 Letter box image				
1080i	 For 16:9 aspect ratio				
720p					

# COMPUTER

		4:3	16:9	Native
For 4:3 aspect ratio	VGA(640X480)	960X720	1280X720	640X480
	SVGA(800X600)	960X720	1280X720	800X600
	XGA(1024X768)	960X720	1280X720	1024X768
	SXGA(1280X1024)	960X720	1280X720	1280X1024

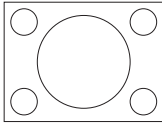
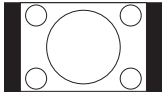
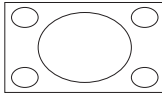
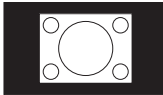
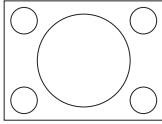
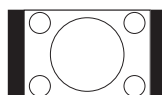
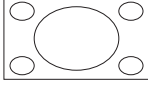
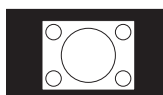
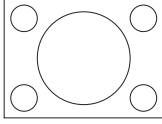
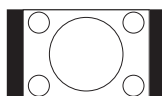
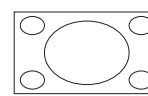
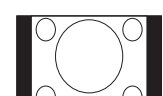
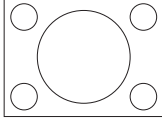
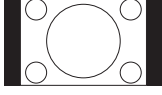
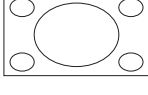
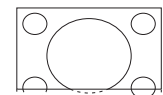
	Input Signal	Output screen image		
		4:3	16:9	Native
VGA	 For 4:3 aspect ratio (640x480)			
SVGA	 For 4:3 aspect ratio (800x600)			
XGA	 For 4:3 aspect ratio (1024x768)			
SXGA	 For 4:3 aspect ratio (1280x1024)			

# Option Menu

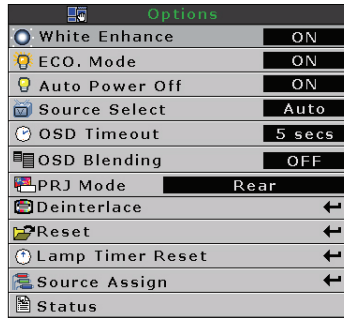

Item	Description
White Enhance	<p>Use this option to adjust: the color: white bright or dark. Press ◀ or ▶ button to enable or disable white color enhancement of the image. Select from ON or OFF.</p> <ul style="list-style-type: none"> <li>• ON: Emphasizes the bright portions of images.</li> <li>• OFF: Disables “White Enhance”.</li> </ul>
ECO. Mode	<p>Press ◀ or ▶ button to enable or disable the power saving of the projector. This mode uses less power and extends the lamp life, but decreases the lamp brightness. Select from ON or OFF.</p> <p><b>Note:</b></p> <ul style="list-style-type: none"> <li>• Although noise is reduced when “ECO” is set to “ON”, the brightness decreases by 20%.</li> <li>• “ECO” mode is “ON” by default.</li> </ul>
Auto Power Off	<p>Press ◀ or ▶ button to enable or disable the Auto Power Off mode. Select from ON or Off. When set to “ON”, 5 minutes before the power turns off, the message shown right will appear on the screen to indicate the remaining minutes.</p> <div data-bbox="838 877 1241 963" style="border: 1px solid black; padding: 5px; text-align: center;"> <p>Auto Power Off 5 : 00 ☀️ → 🌑 Press any key to stop auto power off.</p> </div> <p><b>Note:</b> When the Auto Power Off function is set to “ON”, a warning, “Power OFF in 5 min.” displays five minutes before the power turns off.</p>
Source Select	<p>Press ◀ or ▶ button to select the Source output mode. Select from Manual or Auto.</p>
OSD Timeout	<p>Press ◀ or ▶ button to set the OSD timeout option. Select from 5 secs, 15 secs, or 60 secs.</p>
OSD Blending	<p>This function allows you to set the transparency of the OSD menu. When set to transparent, you can see the image behind the menu. Press ◀ or ▶ button to enable or disable the on-screen display behind the menu. Select from ON or OFF.</p>
PRJ Mode	<p>Press ◀ or ▶ button to set the image projection mode. This function can be used for the reversed image and ceiling-mount setups. Select from Front, Front Ceiling, Rear, or Rear Ceiling.</p>

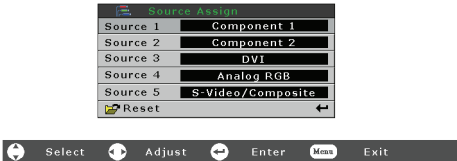
Item	Description
Deinterlace	<p>This function allows you to determine the type of incoming video content—film, static interlaced video and moving interlaced video. Different algorithms are applied for each of the content types. Press ◀ or ▶ button to set the deinterlace mode.</p> <ul style="list-style-type: none"> <li>• <b>DCTI:</b> This function is useful to enhance video by replacing the edges of the video with edges that have steeper rise and fall times. DCTI turns sloped or sinusoidal waveforms into rectangular or square waveforms with the same duty cycles and peak-to-peak amplitude. It's useful for 4:1:1 video sources. The range is from 0 to 7.</li> <li>• <b>Video on film (VOF):</b> This function is used to identify video artifacts while in film mode. VOF attempts to repair the artifacts using the low-angle interpolator while remaining in film mode.</li> <li>• <b>Film Mode:</b> Reproduces the image of the film source clearly. Displays the optimized image of film transformed with 3:2 pull down (NTSC and PAL60Hz) or 2:2 pull down (PAL 50Hz and SECAM) enhancement to progressive mode images.</li> </ul> <p><b>Note:</b> In PAL50Hz or SECAM, the 2:2 pull down enhancement will be enabled only in film mode, after the film source has been entered.</p>
Reset	Press ⏪ button to return to the default setting.
Lamp Timer Reset	<p>The projector keeps a record of the total time the lamp has been in use. You should reset the timer after you install a new lamp. The total lamp usage time is shown in the Status Screen.</p> <p>Press ⏪ button to reset the lamp timer.</p>
Source Assign	<p>Press ◀ or ▶ button to assign the source to the remote control source buttons. Different source buttons can share the same source. See the defaults as shown below:</p> 
Status	Press ⏪ button to view current status.

## Input Source Menu

In the Main menu, press ▲ or ▼ button to select Input Source, and press  button to confirm.

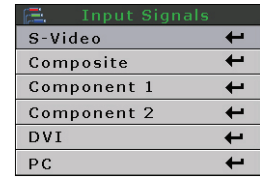
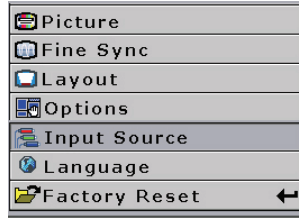

### Notes

- When a signal is not received, “Searching” is displayed.
- If you select “Auto” as the input source, then the correct input source is automatically selected.

## Language Menu

In the Main menu, press ▲ or ▼ button to select Language menu, and press  button to confirm.



## Factory Reset

In the Main menu, press ▲ or ▼ button to select Factory Reset option and press  button to confirm. The projector will return to factory default setting.







# Appendix

# Maintenance

## Cleaning the projector

- Unplug the power cord before cleaning the projector.
- Avoid using benzene or thinners, as these can damage the finish on the cabinet and operation panel.
- Do not use volatile agents, such as insecticides, on the projector.
- Do not leave rubber or plastic objects in contact with the projector for long periods, as they may damage the finish of the projector.

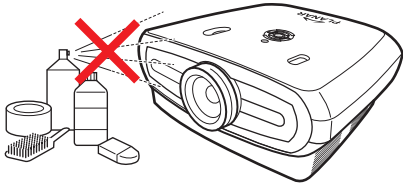

- Wipe off dirt gently with a soft flannel cloth.
- For hard-to-remove dirt, soak a cloth in a neutral detergent diluted with water, wring the cloth well and then wipe the projector.  
Strong cleaning detergents may discolor, warp or damage the coating on the projector. Make sure to test on a small, inconspicuous area on the projector before use.

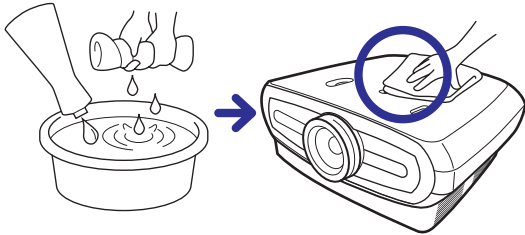

## Cleaning the lens

- Use a commercially available blower or lens cleaning paper (for glasses and camera lenses) for cleaning the lens. Do not use any liquid cleaning agents, as they may wear off the coating film on the surface of the lens.

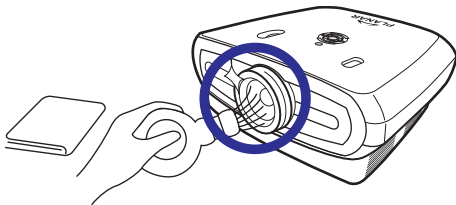

- The surface of the lens is easily damaged, do not to scrape or hit the lens.

# About the Lamp

The projector lamp has a life span of approximately 2000 hours. Maintain proper ventilation to keep the lamp operating throughout its lifetime. Do not subject the projector to unnecessary vibrations to ensure that the lamp does not break.

- It is recommended that the lamp (sold separately) be replaced after approximately 2,000 cumulative hours of use or when you notice a significant deterioration in the picture and color quality. The number of hours the lamp has been used can be checked with “Lamp Timer” in the “Options” menu on the menu screen.
- For lamp replacement, please consult your nearest authorized service center or dealer.
- The actual lamp service life may be less than 2000 hours depending on the environment in which the projector is used.

## Caution Concerning the Lamp

- This projector uses a pressurized mercury lamp. A loud sound may indicate lamp failure. Lamp failure is caused by excessive shock, improper cooling, surface scratches or deterioration of the lamp due to usage. The period of time up to failure largely varies depending on the individual lamp and/or the condition and the frequency of use. It is important to note that failure can often result in the bulb cracking.
- When the lamp replacement indicator and on-screen display icon are illuminated or are flashing, it is recommended that the lamp be replaced immediately, even if the lamp appears to be operating normally.
- If the lamp breaks, glass particles may spread inside the lamp cage or gas contained in the lamp may be vented into the room from the exhaust vent. As the gas in this lamp contains mercury, ventilate the room well if the lamp breaks and avoid exposure. In case of exposure to the gas, consult a doctor as soon as possible.
- If the lamp breaks, there is also a possibility that glass particles may spread inside the projector. If this happens, it is recommended you contact your nearest authorized dealer to remove the damaged lamp and assure safe operation.

## Replacing the Lamp



**CAUTION!** Do not remove the lamp unit immediately after operation of the projector. The lamp will be hot and touching it may cause injury. Wait at least one hour after the power cord is disconnected to allow the surface of the lamp unit to fully cool before removing.

## Temperature LED (Temperature Overheat Alarm)

The temperature LED acts as an alarm to alert you when the projector lamp becomes too hot.

If the LED illuminates during operation, the lamp shuts off and the cooling fan continues to run for approximately two minutes. You should ensure that the airflow around the projector is sufficient and that the cooling fan intake vent is not clogged to ensure that the projector has proper ventilation.

Please pay attention that the cooling fan and intake vent are not clogged. Please see “Projector (Front and Top View)” on page 3 for their location.

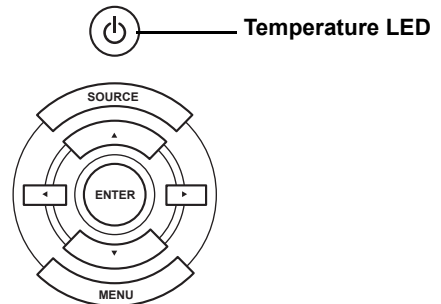

In addition to the LED illuminating, the following warning is also projected:



**Temperature Overheat!**

# Removing and Replacing the Lamp

Follow these instructions to replace the lamp.

- Remove the lamp unit by the handle. Do not touch the glass surface of the lamp unit or the inside of the projector.
- To avoid injuring yourself and damaging the lamp, carefully follow the steps below.
- Only loosen the screws for the lamp unit cover and lamp unit.

(Only the silver screws are loosened).

1. **If the projector is running, press  on the projector or  on the remote control to turn off the power. Wait until the cooling fan stops.**

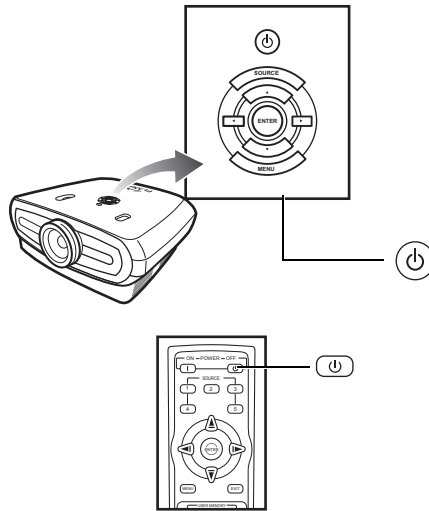

## Warning!

Do not remove the lamp unit from the projector immediately after use. The lamp will be very hot and may cause injury.

2. **Disconnect the power cord and wait at least an hour for the lamp to cool.**
3. **Remove the lamp unit cover.**

- Loosen the screw that secures the lamp unit cover. Now open the cover in the direction of the arrow.

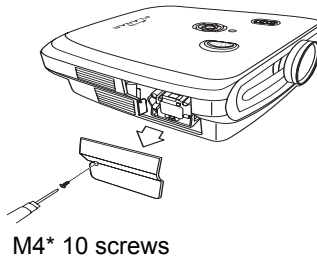

#### 4. Remove the lamp unit.

- Loosen the securing screws from the lamp unit. Hold the lamp unit by the handle and pull it in the direction of the arrow.

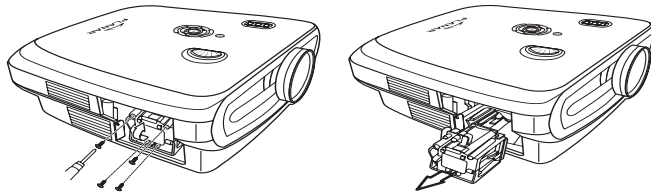

#### 5. Insert the new lamp unit.

- Press the lamp unit firmly into the lamp unit compartment. Fasten the securing screws.
- Attach the lamp unit cover.
- Close the lamp unit cover in the direction of the arrow (to the close mark) on the side of the projector.
- Tighten the cover screw.

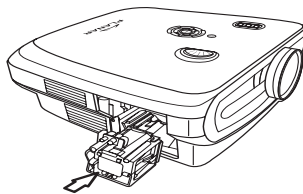

#### Info

- If the lamp unit and lamp cover are not correctly installed, the power will not turn on.

## Resetting the Lamp Timer

Reset the lamp timer after replacing the lamp.

#### 1. Connect the power cord.

- Plug the power cord into the AC socket of the projector.

#### 2. Reset the lamp timer.

- In the OSD Main menu, press ▲ or ▼ button to select **Option** menu.
- Press ◀ or ▶ button to select **Lamp Timer Reset**.
- Press  to confirm, and "LAMP 0H" is displayed. The lamp timer is reset.

#### Info

Only reset the lamp timer when replacing the lamp. If you reset the lamp timer and continue to use the same lamp, this may cause the lamp to become damaged or explode.

# Connecting Pin Assignments

**DVI-D port: 25 pin connector**

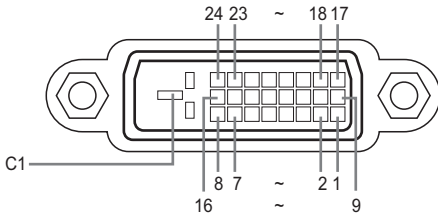

## • VI Digital INPUT

Pin No.	Signal	Pin No.	Signal
1	T.M.D.S data 2-	16	Hot plug detection
2	T.M.D.S data 2+	17	T.M.D.S data 0-
3	T.M.D.S data 2 shield	18	T.M.D.S data 0+
4	Not connected	19	T.M.D.S data 0 shield
5	Not connected	20	Not connected
6	DDC clock	21	Not connected
7	DDC data	22	T.M.D.S clock shield
8	Not connected	23	T.M.D.S clock+
9	T.M.D.S data 1-	24	T.M.D.S clock-
10	T.M.D.S data 1+	C1	Ground
11	T.M.D.S data 1 shield		
12	Not connected		
13	Not connected		
14	+5V power from graphic card.		
15	Ground		

**RS-232C Port: 9-pin D-sub Female connector of the DIN-D-sub RS-232Cvt cable pin connector**

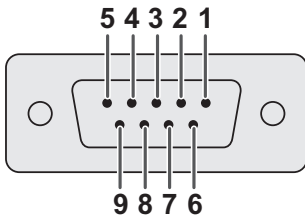

Pin No.	Signal	Name	I/O	Reference
1				Not connected
2	SD	Send Data	Input	Connected to internal circuit
3	RD	Receive Data	Output	Connected to internal circuit
4				Not connected
5	SD	Signal Ground		Connected to internal circuit
6				Not connected
7				Not connected
8				Not connected
9				Not connected

# Computer Compatibility Chart

## Computer

- Multiple signal support  
Horizontal Frequency: 25–75 kHz, Vertical Frequency: 50–85 Hz, Pixel Clock: 25–108 MHz
- Compatible with sync on green and composite sync signals
- XGA compatible with advanced intelligent compression

The following is a list of modes that conform to VESA. However, this projector supports other signals that are not VESA standards.

PC/ MAC/ WS	Resolution	Horizontal Frequency (kHz)	Vertical Frequency (kHz)	VESA Standard	DVI Support	
PC	VGA	640 x 350	31.5	70		✓
			31.5	60		
	640 x 480	37.9	72	✓		
		37.5	75	✓		
		43.3	85	✓		

Resolution	Horizontal Frequency (kHz)	Vertical Frequency (kHz)	VESA Standard	DVI Support	Display
720 × 480	31.5	60		✓	Upscale
720 × 576	31.3	50			
1280 × 720	45	60			
	37.5	50			
1980 × 1080i	33.8	60			
	28.1	50			

PC/ MAC/ WS	Resolution	Horizontal Frequency (kHz)	Vertical Frequency (kHz)	VESA Standard	DVI Support	
PC	SVGA	800 x 600	35.1	56	✓	✓
			37.9	60		
			48.1	72		
			46.9	75		
	XGA	1024 x 768	48.4	60	✓	✓
			56.5	70		
			60.0	75		
		68.7	85			
MAC 13"	VGA	640 x 480	34.9	67		
MAC 16"	SVGA	832 x 624	49.6	75		
MAC 19"	XGA	1024 x 768	48.4	60	✓	
	SXGA	1280 x 1024	64	60	✓	✓



## Notes

- This projector may not be able to display images from notebook computers in simultaneous (CRT/LCD) mode. Should this occur, turn off the LCD display on the notebook computer and output the display data in "CRT only" mode. Details on how to change display modes can be found in your notebook computer's operation manual.
- When this projector receives 640 × 350 VESA format VGA signals, "640 × 400" appears on the screen.
- When projecting video images of an interlaced video signal, the intended image may not be projected when using the RGB input. In such cases, use the component input, S-video input or video input.

# Video Compatibility Chart









	Resolution		H-Freq (kHz)	V-Freq (Hz)	Comp1 Support	Comp2 Support	S-Video Support	Composite Support	VGA Support	DVI Support
SD Video	NTSC	640x480i	15.73	59.94/60	✓	✓	✓	✓		
	PAL	768x576i	15.63	50	✓	✓	✓	✓		
	SECAM	768x576i	15.63	50	✓	✓	✓	✓		
	NTSC-4.43				△	△	△	△		
	PAL-M				△	△	△	△		
	PAL-N				△	△	△	△		
	NTSC-J				△	△	△	△		
	PAL-60				△	△	△	△		
	NTSC-50									
ED TV	480p	720x480p	31.5	59.94/60	✓	✓			✓	✓
	576p	720x576p	31.3	50	✓	✓			✓	✓
HD TV	1080i/50	1920x1080i	33.8	50	✓	✓			✓	✓
	1080i/60	1920x1080i	28.1	59.94/60	✓	✓			✓	✓
	720p/50	1280x720p	37.5	50	✓	✓			✓	✓
	720p/60	1280x720p	45.0	59.94/60	✓	✓			✓	✓
HTPC	720p/48	1280x720p		48						
	720p/75	1280x720p		75						

1. Component 1/2 support signal formats are Y/Pb/Pr, Y/Cb/Cr
2. VGA port support signal formats are RGsyncB, RGBHV or RGBCsysc
3. "△" means manual setting is needed

## DTV

Signal	Horizontal Frequency (kHz)	Vertical Frequency (Hz)	DVI Support
480p	31.5	60	✓
576p	31.3	50	✓
720p	45.0	60	✓
720p	37.5	50	✓
1080i	33.8	60	✓
1080i	28.1	50	✓



Problem	Check
 Projector does not start	<p data-bbox="471 215 1186 253">Projector power cord is not plugged into the wall outlet.</p> <p data-bbox="471 306 1186 344">Remote control batteries have run out.</p>
 No picture	<p data-bbox="471 405 1186 443">The selected input mode is wrong.</p> <p data-bbox="471 449 1186 487">Cables may be incorrectly connected to the rear panel of the projector.</p> <p data-bbox="471 493 1186 531">Power to the external connected device is off.</p> <p data-bbox="471 536 1186 575">The video signal format of the video equipment is not set correctly.</p>
 Color is faded	<p data-bbox="471 658 1186 696">Picture adjustments are incorrectly set.</p>
 Picture is blurred	<p data-bbox="471 776 1186 814">Focus is incorrectly set.</p> <p data-bbox="471 868 1186 906">The projection distance exceeds the focus range.</p>
 Picture contains noise	<p data-bbox="471 967 1186 1005">(PC input only)</p> <p data-bbox="471 1011 1186 1049">Try "Auto tune".</p> <p data-bbox="471 1054 1186 1092">Adjust the "Clock" setting.</p> <p data-bbox="471 1098 1186 1136">Adjust the "Phase" setting.</p>
 Picture is green on INPUT1 or 2 COMPONENT	<p data-bbox="471 1229 1186 1268">Change the input signal type of the video equipment.</p>
 Picture is dark or bright and whitish	<p data-bbox="471 1439 1186 1477">Picture adjustments are incorrectly set.</p>
 Picture is too bright and whitish	<p data-bbox="471 1648 1186 1686">Picture adjustments are incorrectly set.</p>

# Product Specifications

<b>Item</b>	<b>Description</b>
Model No.	PD7130/PD7150 DLP Front Projector
DLP Panel	Display method: PD7130 → 0.65" WXGA, DC3. PD7150 → 0.8" HD2 + DC3
Display Type	Device method: Digital Light Processing (DLP®)
Resolution	DLP Chip, RGB optical shutter method 1280 x 720 pixels
Lens	7130: F2.4~2.5, f=19.1~23.9 7150: F2.36~2.5, f=24.0~30.1
Projection Lamp	250 W / 200 W switchable UHP lamp
Input Sources	Video VGA YCbCr, YPbPr1, 2 CVBS (Composite Video) S-Video DVI-D Control RS-232 (For computer) IR Receiver 12V trigger
Computer Compatibility	VGA, SVGA, XGA, SXGA
2D Lens Shift Ability	PD7130 Up/Down: +115%/-100% PD7150 Up/Down: +100%/-65% Left/Right: ± 15%
Brightness	PD7130: 900 ANSI Lumen PD7150: 1000 ANSI Lumen
Digital Keystone Correction	2D keystone correction
Projection Lens	Zoom lens with manual focus and manual zoom adjust
Contrast Ratio	PD7130: 4500:1 PD7150: 5000:1
Uniformity	90%
Screen Size	30 ~ 300 inches
Throw Ratio (16:9)	1.34:1 ~ 1.68:1
Aspect Ratio	16:9 Native
Projection Distance	1.7 m ~ 5.7 m
Video Enhance	4-Line Y/C separation(2D) DLTi, DCTi
Projection Method	Front / Rear, Desktop / Ceiling
OSD Control	Projector keypad IR remote control
Video system	NTSC 3.58 / NTSC 4.43 / PAL / PAL-M / PAL-N / PAL 60 / SECAM / SDTV-480i/576i, EDTV-480p/576p, HDTV-720p/1080i
Dimensions (W x L x H)	PD7130: 445 mm x 420 mm x 180 mm (17.5" x 16.5" x 7.1") PD7150: 445 mm x 420 mm x 180 mm (17.5" x 16.5" x 7.1")
Weight	17.6 lbs
Power Supply	100 ~ 240 V at 50 ~ 60 Hz
Power Consumption	370 W (Standby mode < 5W)
Operating Temperature	5°C to 35°C
Audible Noise	29dBA (Eco mode)

Specifications are subjected to change without notice.

# Dimensions

PD7130

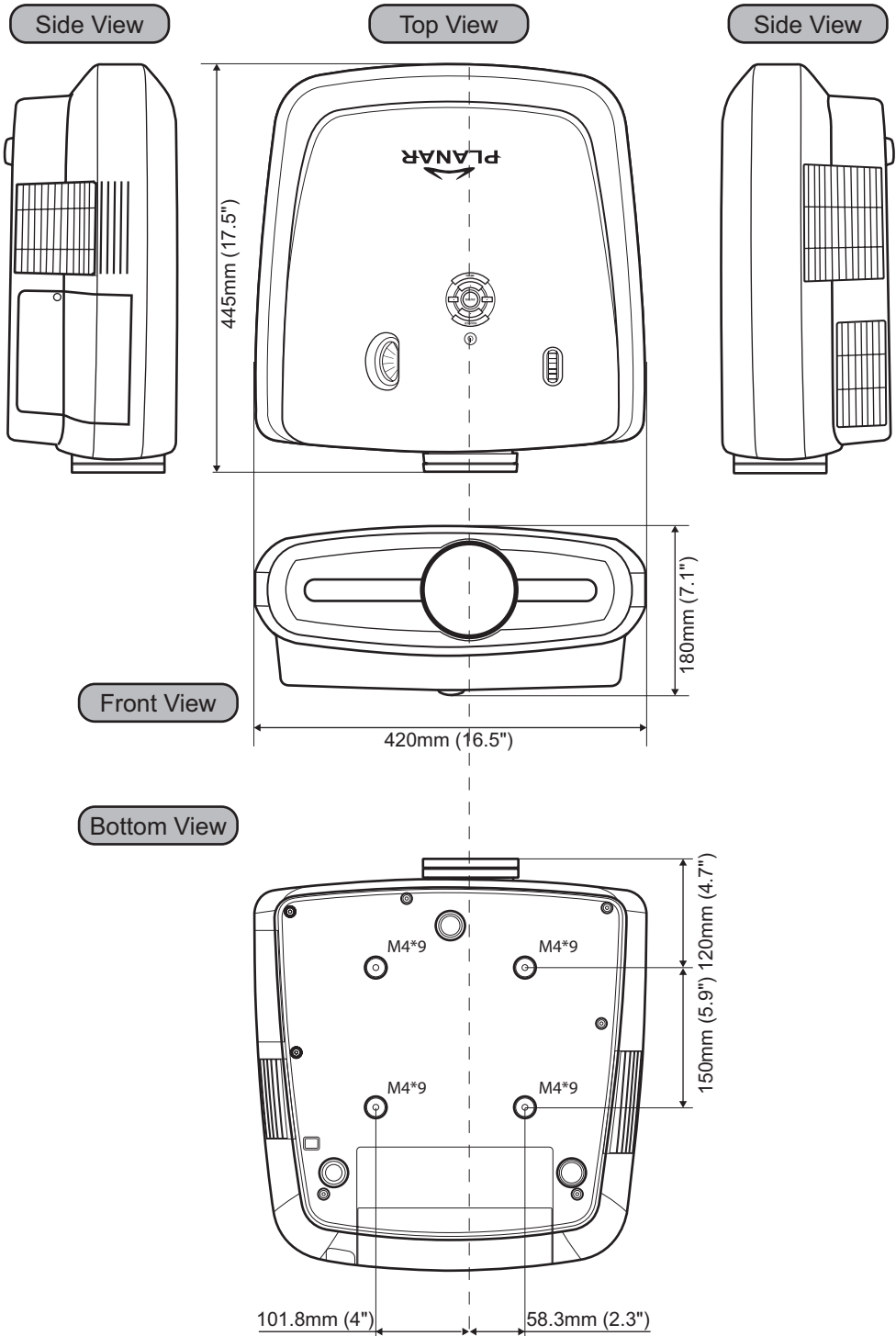

Appendix

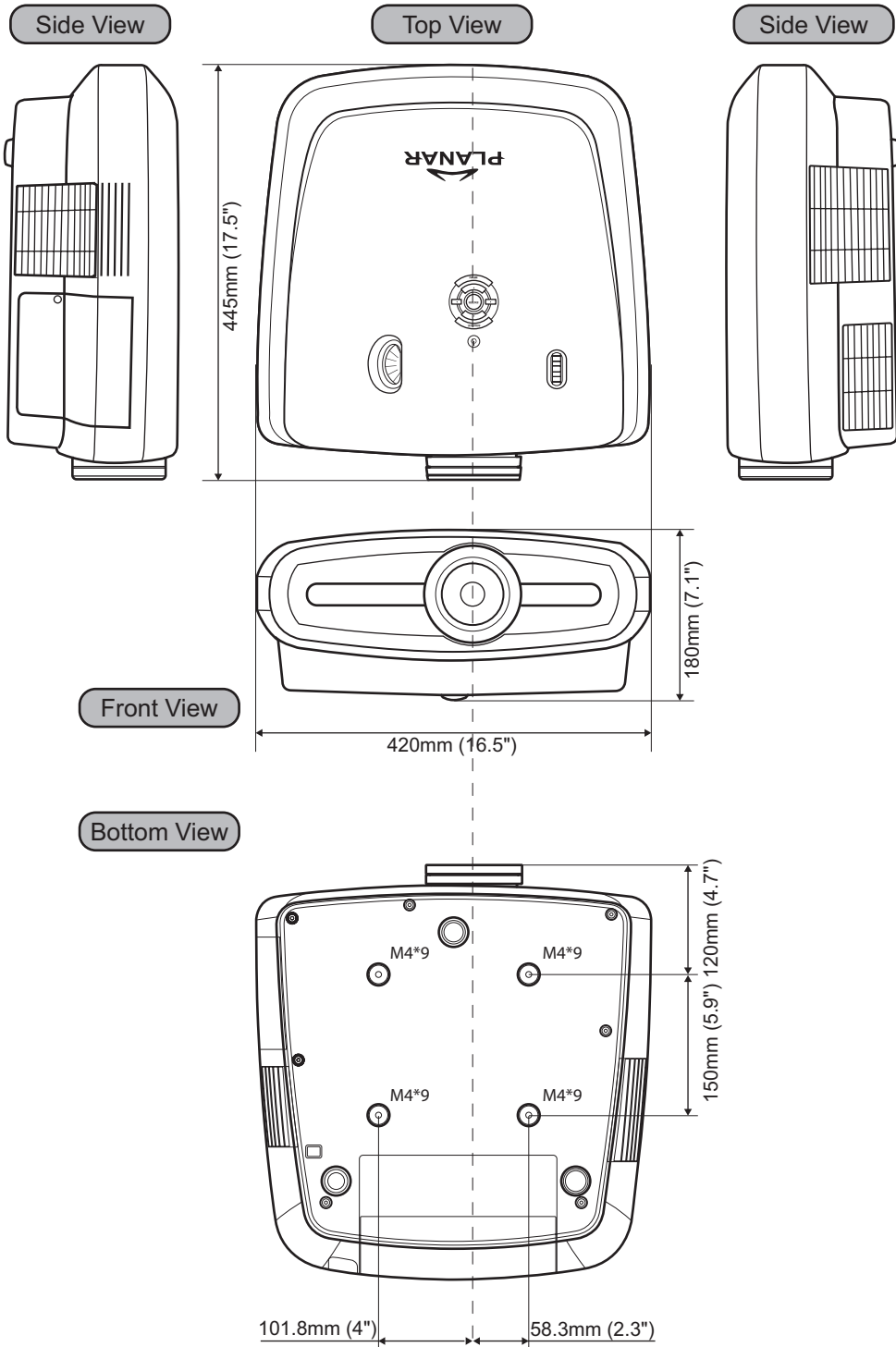

## **Planar Systems, Inc.**

Corporate Headquarters  
1195 NW Compton Drive  
Beaverton, OR 97006-1992

### **Planar Customer Support**

Telephone:  
US: 1-866-PLANAR1 (866) 752-6271  
Outside US: (503) 748-5799  
E-mail: [PlanarSupport@planar.com](mailto:PlanarSupport@planar.com)  
Online Technical Library: <http://www.planar.com/support>  
Hours: M-F, 8am-8pm ET, 12pm-12am GMT

© 2006 Planar Systems, Inc. Planar is a registered trademark of Planar System, Inc.  
Other brands and names are the property of their respective owners.  
Technical information in this document is subject to change without notice